

# IRLR7811WCPbF

HEXFET® Power MOSFET

### Applications

- High Frequency Synchronous Buck Converters for Computer Processor Power
- High Frequency Isolated DC-DC Converters with Synchronous Rectification for Telecom and Industrial Use
- Lead-Free

V <sub>DSS</sub>	R <sub>DS(on)</sub> max	Q <sub>g</sub>
30V	10.5mΩ	19nC

### Benefits

- Very Low RDS(on) at 4.5V V<sub>GS</sub>
- Ultra-Low Gate Impedance
- Fully Characterized Avalanche Voltage and Current



### Absolute Maximum Ratings

	Parameter	Max.	Units
I <sub>D</sub> @ T <sub>C</sub> = 25°C	Continuous Drain Current, V <sub>GS</sub> @ 10V	64 <sup>④</sup>	A
I <sub>D</sub> @ T <sub>C</sub> = 100°C	Continuous Drain Current, V <sub>GS</sub> @ 10V	45 <sup>④</sup>	
I <sub>DM</sub>	Pulsed Drain Current <sup>①</sup>	260	
P <sub>D</sub> @ T <sub>C</sub> = 25°C	Power Dissipation	71	W
P <sub>D</sub> @ T <sub>A</sub> = 100°C	Power Dissipation*	1.5	
	Linear Derating Factor	0.48	W/°C
V <sub>GS</sub>	Gate-to-Source Voltage	± 12	V
T <sub>J</sub>	Operating Junction and	-55 to + 175	°C
T <sub>STG</sub>	Storage Temperature Range		
	Soldering Temperature, for 10 seconds	300 (1.6mm from case )	

### Thermal Resistance

	Parameter	Typ.	Max.	Units
R <sub>θJC</sub>	Junction-to-Case	—	2.1	°C/W
R <sub>θJA</sub>	Junction-to-Ambient (PCB mount)*	—	50	
R <sub>θJA</sub>	Junction-to-Ambient	—	110	

Notes <sup>①</sup> through <sup>④</sup> are on page 9  
[www.irf.com](http://www.irf.com)

# IRLR7811WCPbF

International  
**IR** Rectifier

## Static @ T<sub>J</sub> = 25°C (unless otherwise specified)

	Parameter	Min.	Typ.	Max.	Units	Conditions
BV <sub>DSS</sub>	Drain-to-Source Breakdown Voltage	30	—	—	V	V <sub>GS</sub> = 0V, I <sub>D</sub> = 250μA
ΔBV <sub>DSS</sub> /ΔT <sub>J</sub>	Breakdown Voltage Temp. Coefficient	—	27	—	mV/°C	Reference to 25°C, I <sub>D</sub> = 1mA ⑥
R <sub>DS(on)</sub>	Static Drain-to-Source On-Resistance	—	5.8	10.5	mΩ	V <sub>GS</sub> = 10V, I <sub>D</sub> = 15A ④
		—	7.0	15		V <sub>GS</sub> = 4.5V, I <sub>D</sub> = 12A
V <sub>GS(th)</sub>	Gate Threshold Voltage	—	1.5	2.5	V	V <sub>DS</sub> = V <sub>GS</sub> , I <sub>D</sub> = 250μA
ΔV <sub>GS(th)</sub> /ΔT <sub>J</sub>	Gate Threshold Voltage Coefficient	—	-5.0	—	mV/°C	
I <sub>DSS</sub>	Drain-to-Source Leakage Current	—	—	30	μA	V <sub>DS</sub> = 24V, V <sub>GS</sub> = 0V
		—	—	150		V <sub>DS</sub> = 24V, V <sub>GS</sub> = 0V, T <sub>J</sub> = 125°C
I <sub>GSS</sub>	Gate-to-Source Forward Leakage	—	—	100	nA	V <sub>GS</sub> = 12V
	Gate-to-Source Reverse Leakage	—	—	-100		V <sub>GS</sub> = -12V
g <sub>fs</sub>	Forward Transconductance	58	—	—	S	V <sub>DS</sub> = 15V, I <sub>D</sub> = 12A
Q <sub>g</sub>	Total Gate Charge Control Fet	—	21	31	nC	
Q <sub>gs1</sub>	Pre-V <sub>th</sub> Gate-Source Charge	—	5.0	—		
Q <sub>gs2</sub>	Post-V <sub>th</sub> Gate-Source Charge	—	1.7	—		
Q <sub>gd</sub>	Gate-to-Drain Charge	—	6.6	—		
Q <sub>godr</sub>	Gate Charge Overdrive	—	5.5	—		
Q <sub>sw</sub>	Switch Charge (Q <sub>gs2</sub> + Q <sub>gd</sub> )	—	8.3	—		
Q <sub>g</sub>	Total Gate Charge Sync Fet	—	17	—		
Q <sub>oss</sub>	Output Charge	—	10	—		
R <sub>g</sub>	Gate Resistance	—	1.6	—		
t <sub>d(on)</sub>	Turn-On Delay Time	—	18	—	ns	V <sub>DD</sub> = 16V, V <sub>GS</sub> = 4.5V ④ I <sub>D</sub> = 12A Clamped Inductive Load
t <sub>r</sub>	Rise Time	—	4.8	—		
t <sub>d(off)</sub>	Turn-Off Delay Time	—	11	—		
t <sub>f</sub>	Fall Time	—	23	—		
C <sub>iss</sub>	Input Capacitance	—	2260	—	pF	V <sub>GS</sub> = 0V V <sub>DS</sub> = 15V f = 1.0MHz
C <sub>oss</sub>	Output Capacitance	—	420	—		
C <sub>rss</sub>	Reverse Transfer Capacitance	—	180	—		

## Avalanche Characteristics

	Parameter	Typ.	Max.	Units
E <sub>AS</sub>	Single Pulse Avalanche Energy②	—	140	mJ
I <sub>AR</sub>	Avalanche Current③	—	12	A
E <sub>AR</sub>	Repetitive Avalanche Energy③	—	7.1	mJ

## Diode Characteristics

	Parameter	Min.	Typ.	Max.	Units	Conditions
I <sub>S</sub>	Continuous Source Current (Body Diode)	—	—	64 ④	A	MOSFET symbol showing the integral reverse p-n junction diode.
I <sub>SM</sub>	Pulsed Source Current (Body Diode) ①	—	—	260		
V <sub>SD</sub>	Diode Forward Voltage	—	—	1.2	V	T <sub>J</sub> = 25°C, I <sub>S</sub> = 12A, V <sub>GS</sub> = 0V ④
t <sub>rr</sub>	Reverse Recovery Time	—	30	45	ns	T <sub>J</sub> = 25°C, I <sub>F</sub> = 12A
Q <sub>rr</sub>	Reverse Recovery Charge	—	27	41	nC	di/dt = 100A/μs ④
t <sub>on</sub>	Forward Turn-On Time	Intrinsic turn-on time is negligible (turn-on is dominated by L <sub>S</sub> +L <sub>D</sub> )				

# IRLR7811WCPbF

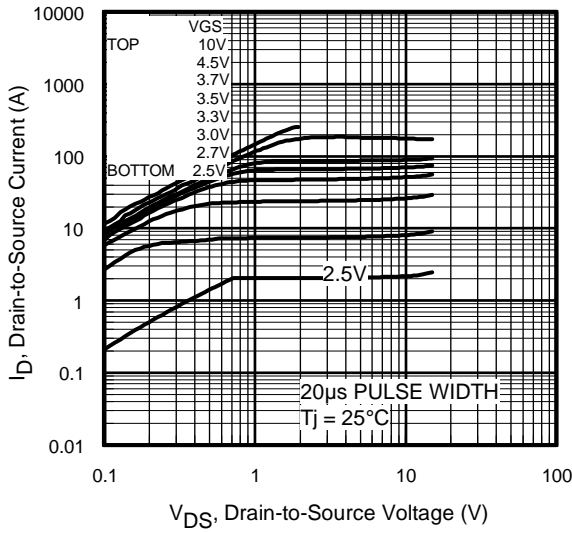

Fig 1. Typical Output Characteristics

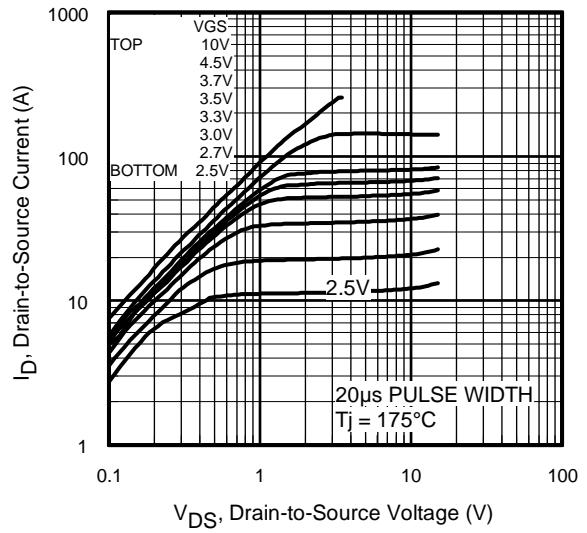

Fig 2. Typical Output Characteristics

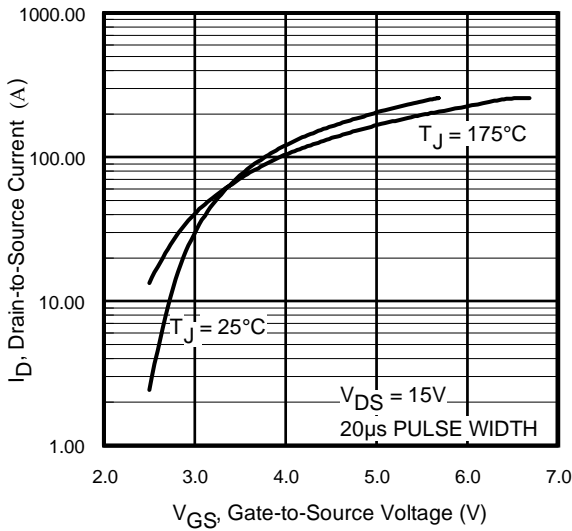

Fig 3. Typical Transfer Characteristics

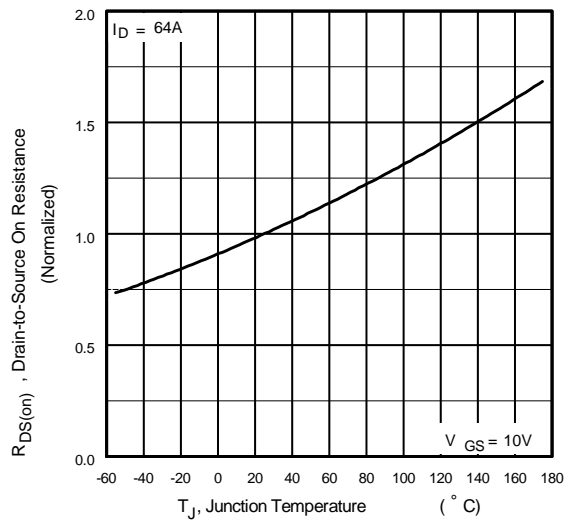
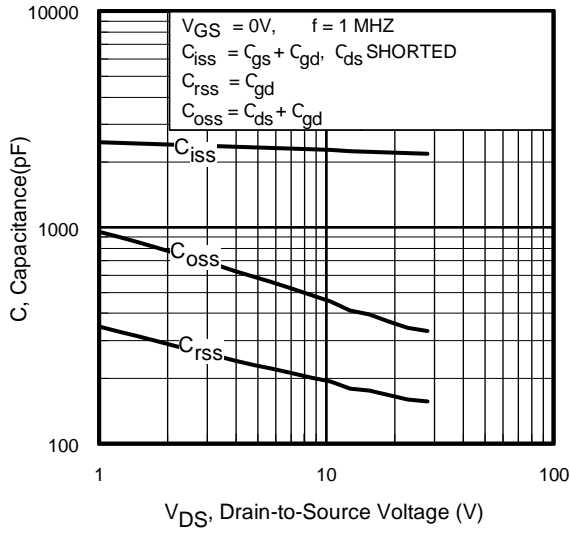
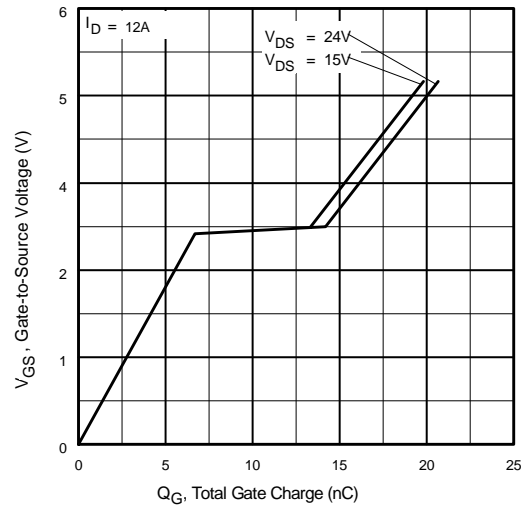

Fig 4. Normalized On-Resistance Vs. Temperature

# IRLR7811WCPbF



**Fig 5.** Typical Capacitance Vs. Drain-to-Source Voltage



**Fig 6.** Typical Gate Charge Vs. Gate-to-Source Voltage

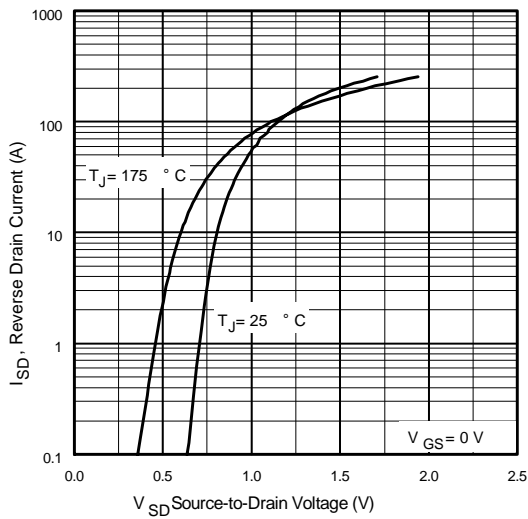

**Fig 7.** Typical Source-Drain Diode Forward Voltage

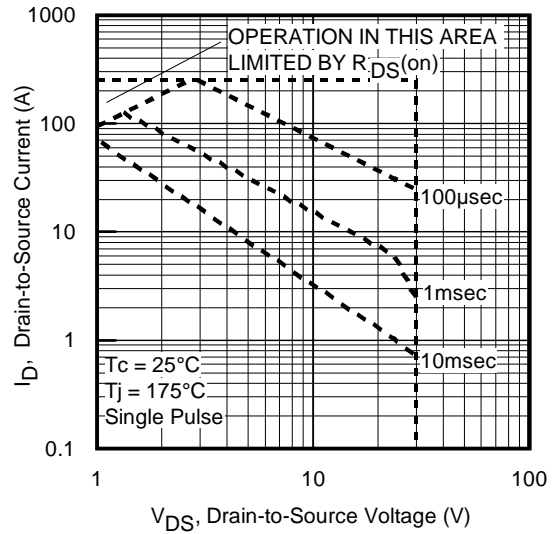

**Fig 8.** Maximum Safe Operating Area

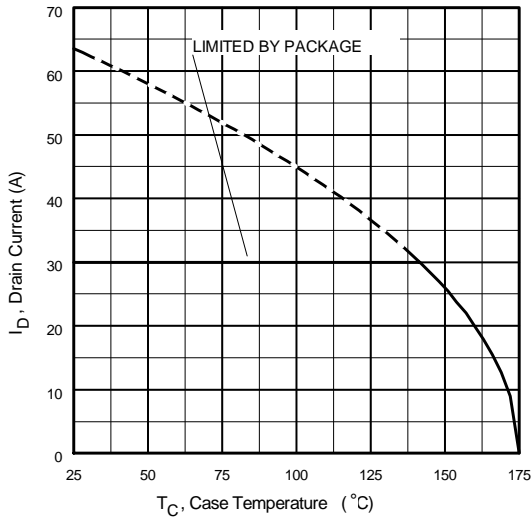

**Fig 9.** Maximum Drain Current Vs. Case Temperature

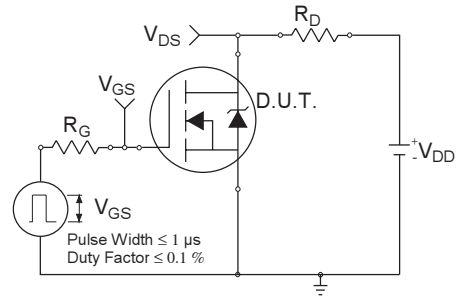

**Fig 10a.** Switching Time Test Circuit



**Fig 10b.** Switching Time Waveforms

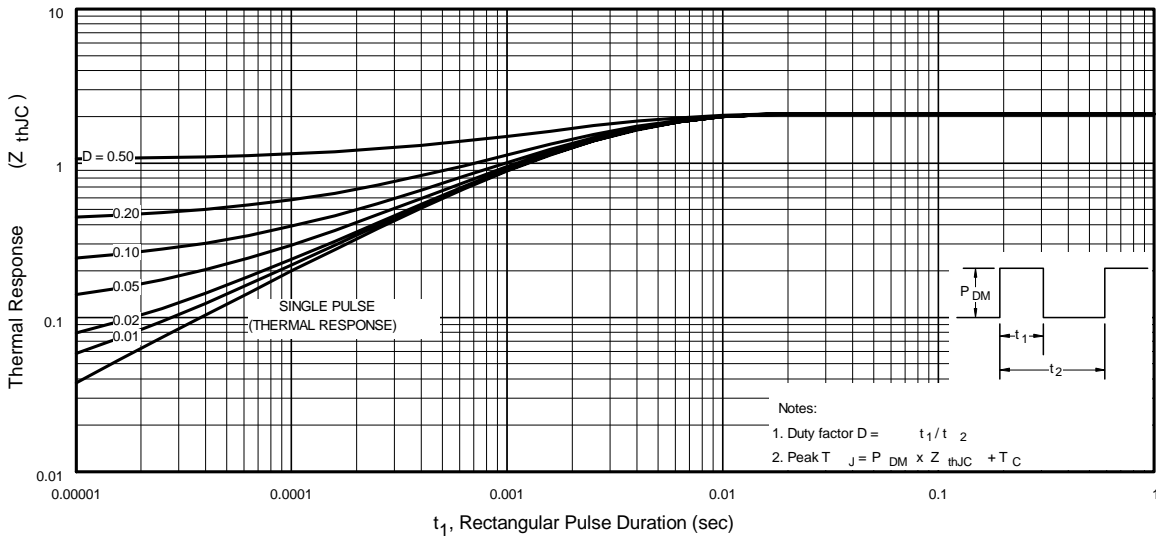

**Fig 11.** Maximum Effective Transient Thermal Impedance, Junction-to-Case

# IRLR7811WCPbF



**Fig 12a.** Unclamped Inductive Test Circuit



**Fig 12b.** Unclamped Inductive Waveforms

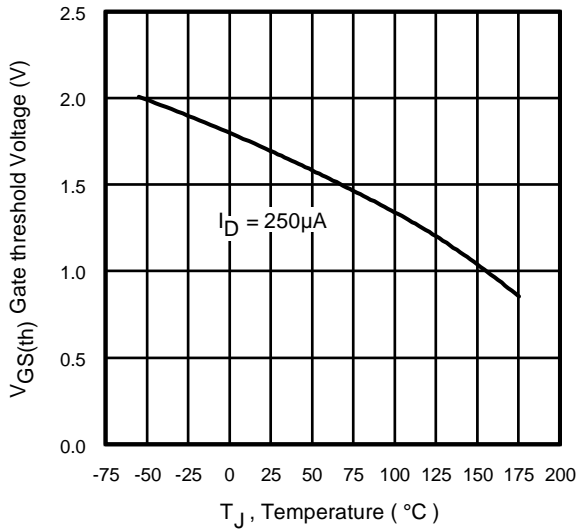

**Fig 13.** Threshold Voltage Vs. Temperature

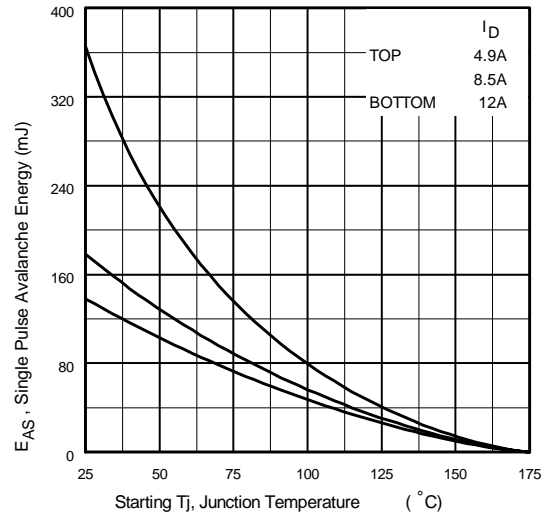
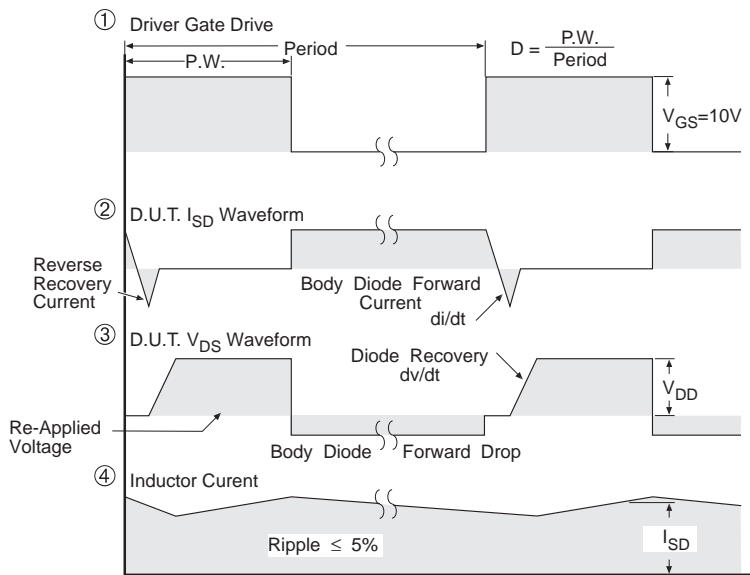

**Fig 12c.** Maximum Avalanche Energy Vs. Drain Current



**Fig 14.** Gate Charge Test Circuit

**Peak Diode Recovery dv/dt Test Circuit**



\*  $V_{GS} = 5V$  for Logic Level Devices

**Fig 15.** For N-Channel HEXFET® Power MOSFETs

# IRLR7811WCPbF

International  
**IR** Rectifier

## D-Pak (TO-252AA) Package Outline

Dimensions are shown in millimeters (inches)

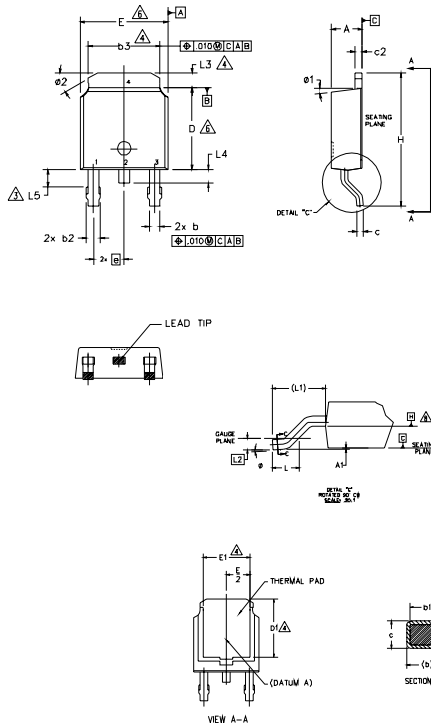

- NOTES:
- 1.- DIMENSIONING AND TOLERANCING PER ASME Y14.5M-1994
  - 2.- DIMENSIONS ARE SHOWN IN INCHES [MILLIMETERS]
  - 3.- LEAD DIMENSION UNCONTROLLED IN L5.
  - 4.- DIMENSION D1, E1, L3 & b3 ESTABLISH A MINIMUM MOUNTING SURFACE FOR THERMAL PAD.
  - 5.- SECTION C-C DIMENSIONS APPLY TO THE FLAT SECTION OF THE LEAD BETWEEN .005 AND 0.10 [0.13 AND 0.25] FROM THE LEAD TIP.
  - 6.- DIMENSION D & E DO NOT INCLUDE MOLD FLASH. MOLD FLASH SHALL NOT EXCEED .005 [0.13] PER SIDE. THESE DIMENSIONS ARE MEASURED AT THE OUTMOST EXTREMES OF THE PLASTIC BODY.
  - 7.- DIMENSION b1 & c1 APPLIED TO BASE METAL ONLY.
  - 8.- DATUM A & B TO BE DETERMINED AT DATUM PLANE H.
  - 9.- OUTLINE CONFORMS TO JEDEC OUTLINE TO-252AA.

SYMBOL	DIMENSIONS				NOTES
	MILLIMETERS		INCHES		
	MIN.	MAX.	MIN.	MAX.	
A	2.18	2.39	.086	.094	
A1	-	0.13	-	.005	
b	0.64	0.89	.025	.035	
b1	0.65	0.79	.025	.031	7
b2	0.76	1.14	.030	.045	
b3	4.95	5.46	.195	.215	4
c	0.46	0.61	.018	.024	
c1	0.41	0.56	.016	.022	7
c2	0.46	0.89	.018	.035	
D	5.97	6.22	.235	.245	6
D1	5.21	-	.205	-	4
E	6.35	6.73	.250	.265	6
E1	4.32	-	.170	-	4
e	2.29 BSC		.090 BSC		
H	9.40	10.41	.370	.410	
L	1.40	1.78	.055	.070	
L1	2.74 BSC		.108 REF.		
L2	0.51 BSC		.020 BSC		
L3	0.89	1.27	.035	.050	4
L4	-	1.02	-	.040	
L5	1.14	1.52	.045	.060	3
ø	0"	10"	0"	10"	
ø1	0"	15"	0"	15"	
ø2	25"	35"	25"	35"	

### LEAD ASSIGNMENTS

### HEXFET

- 1.- GATE
- 2.- DRAIN
- 3.- SOURCE
- 4.- DRAIN

### IGBT & CoPAK

- 1.- GATE
- 2.- COLLECTOR
- 3.- EMITTER
- 4.- COLLECTOR

## D-Pak (TO-252AA) Part Marking Information

EXAMPLE: THIS IS AN IRFR120  
WITH ASSEMBLY  
LOT CODE 1234  
ASSEMBLED ON WW 16, 2001  
IN THE ASSEMBLY LINE "A"

Note: "P" in assembly line position  
indicates "Lead-Free"  
"P" in assembly line position indicates  
"Lead-Free" qualification to the Consumer-level

OR

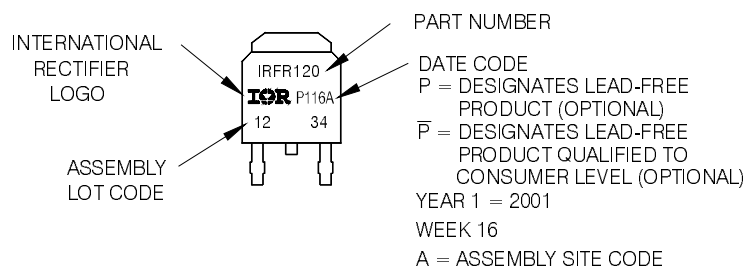
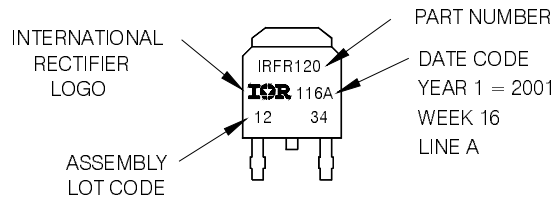



## D-Pak (TO-252AA) Tape & Reel Information

Dimensions are shown in millimeters (inches)

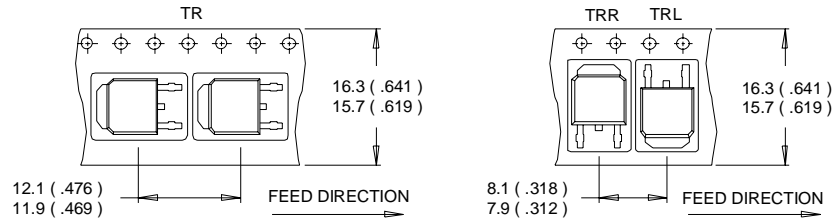

- NOTES :
1. CONTROLLING DIMENSION : MILLIMETER.
  2. ALL DIMENSIONS ARE SHOWN IN MILLIMETERS ( INCHES ).
  3. OUTLINE CONFORMS TO EIA-481 & EIA-541.

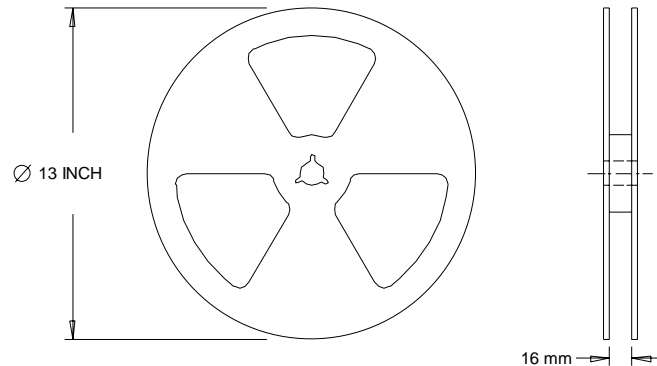

- NOTES :
1. OUTLINE CONFORMS TO EIA-481.

**Notes:**

- |  |   |
|--|---|
| ① Repetitive rating; pulse width limited by max. junction temperature.                                 | ③ Pulse width $\leq 400\mu\text{s}$ ; duty cycle $\leq 2\%$ .   |
| ② Starting $T_J = 25^\circ\text{C}$ , $L = 1.9\text{mH}$<br>$R_G = 25\Omega$ , $I_{AS} = 12\text{A}$ . | ④ Calculated continuous current based on maximum allowable junction temperature. Package limitation current is 30A. |
- \* When mounted on 1" square PCB (FR-4 or G-10 Material).  
 For recommended footprint and soldering techniques refer to application note #AN-994.

Data and specifications subject to change without notice.  
 This product has been designed and qualified for the Consumer market.  
 Qualification Standards can be found on IR's Web site.

Note: For the most current drawings please refer to the IR website at:  
<http://www.irf.com/package/>